

# Hollo-Bolt® by Lindapter®

Installation is quickly carried out by inserting into pre-drilled steelwork and tightening with a torque wrench. Independent approvals include CE Mark, DIBt, TÜV and ICC-ES seismic accreditation.

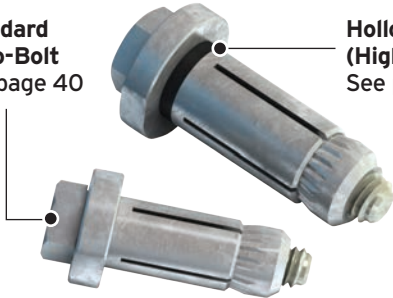

**Standard Hollo-Bolt**  
See page 40



**Hollo-Bolt HCF (High Clamping Force)**  
See pages 40 and 41

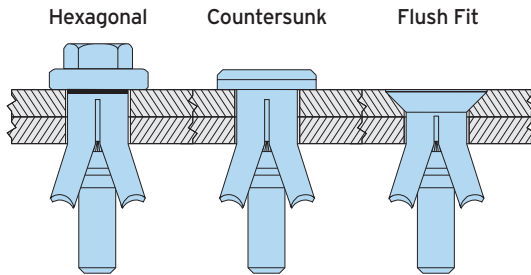

- Fast, cost saving installation from one side.
- For square, rectangular and circular hollow sections.
- High resistance to shear and tension.
- Patented High Clamping Force design.
- A range of head types for architectural finishes.
- CE Mark, DIBt, TÜV and ICC-ES Seismic approvals.

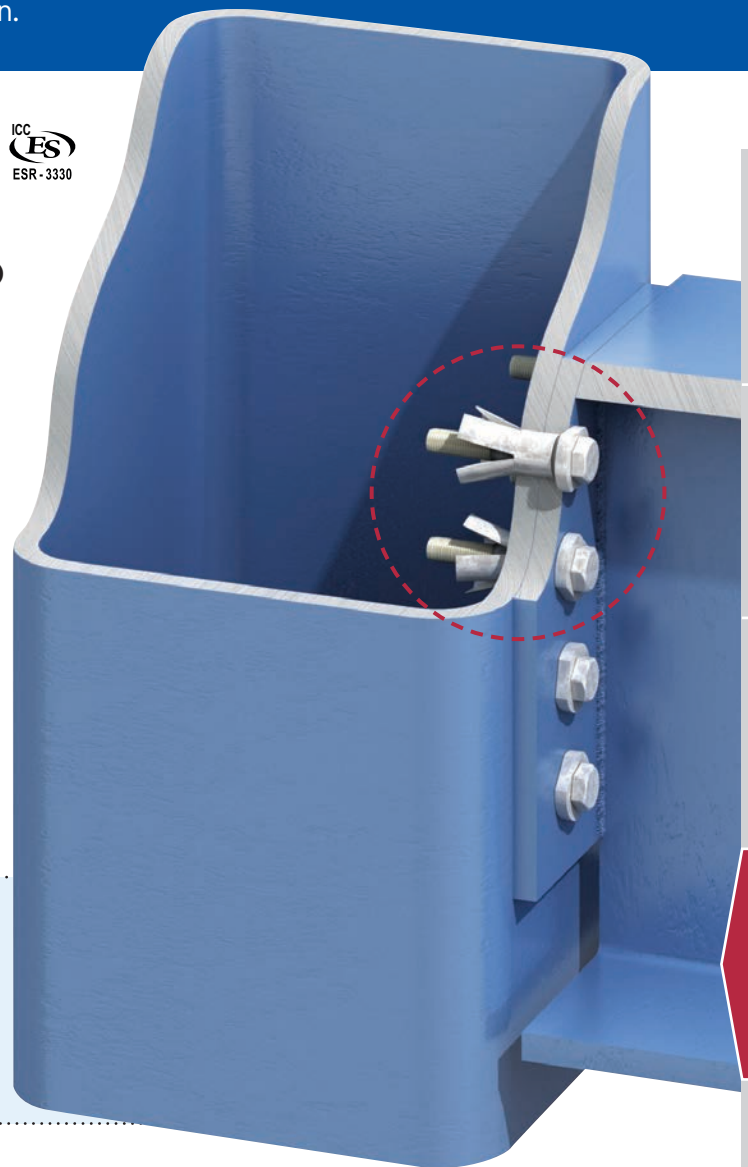

## Hollo-Bolt head variant comparison

Head variants	Sizes					Corrosion protection			
	M8	M10	M12	M16 HCF*	M20 HCF*	JS500	Hot Dip Galv.	Sheraplex	Stainless Steel
<b>Hexagonal</b> Normal visible protrusion	✓	✓	✓	✓	✓	✓	✓	✓	✓
<b>Countersunk</b> Minimal visible protrusion	✓	✓	✓	✓	-	✓	-	✓	✓
<b>Flush Fit</b> Zero visible protrusion	✓	✓	✓	-	-	✓	-	✓	✓

Lindapter can also manufacture customised products for specific connection requirements, e.g. security / button head and special sizes.



\* Sizes M16 and M20, known as the Hollo-Bolt (HCF), feature a High Clamping Force mechanism to produce three times more clamping force than the same sized product without the mechanism. Turn to **pages 40 and 41** to see the significance of clamping force and the superior performance of this unique product.

# Hollo-Bolt High Clamping Force

Lindapter Hollo-Bolts are available in two versions; the original standard design for general hollow section connections and larger sized High Clamping Force (HCF) for higher strength structural connections.

SIZES M8, M10 AND M12

## Standard Hollo-Bolt

A typical connection is made by inserting the Hollo-Bolt into the pre-drilled holes of the fixture and hollow section. As the bolt head is tightened, the cone is pulled up the bolt thread, causing the sleeve to expand until the cone locks the sleeve against the hollow section's inner wall.

At full tightening torque, a clamping force is established between the fixture and the steel section to form a secure connection. Once installed, only the head and collar are visible.

→ ← = Clamping Force

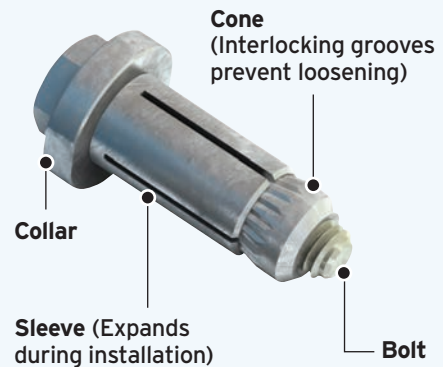
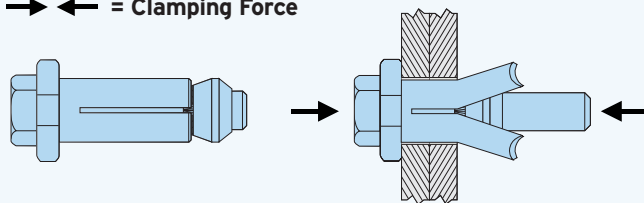

See how to install the Hollo-Bolt on page 44 or watch the video at [www.Lindapter.com](http://www.Lindapter.com)



SIZES M16 AND M20

## Hollo-Bolt HCF

By working closely with Structural Engineers and Steel Fabricators, Lindapter identified the need for the larger M16 and M20 Hollo-Bolts to have an increased clamping force suitable for higher strength structural connections. This led to Lindapter's invention of the High Clamping Force (HCF) design, optimised for superior performance.

The HCF mechanism consists of a special rubber washer that compresses during installation to significantly increase the clamping force between the connecting steelwork, when compared to a product of the same size without the mechanism, thereby reducing displacement.

→ ← = Clamping Force

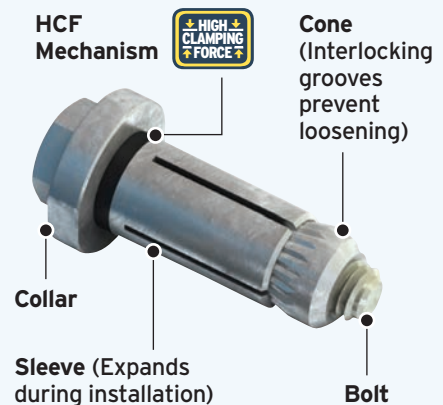
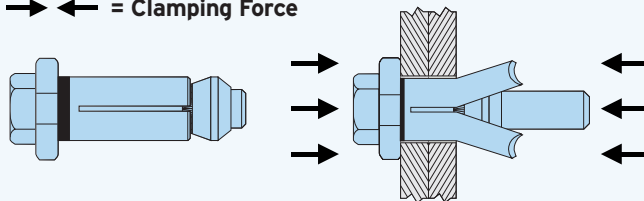

See how to install the Hollo-Bolt on page 44 or watch the video at [www.Lindapter.com](http://www.Lindapter.com)



GIRDER CLAMPS  
RAIL FIXINGS  
LIFTING POINTS  
HOLLO-BOLT  
FLOOR FIXINGS  
SUPPORT FIXINGS  
DECKING FIXINGS

# Hollo-Bolt Clamping Force

Hollo-Bolts are optimised for structural connections and the larger M16 and M20 sizes feature a High Clamping Force (HCF) mechanism. The graphs below compare the performance of a Hollo-Bolt HCF and an expansion bolt of the same size without the mechanism.

## Clamping Force Typical Performance Increase



**M16: Up to 3 times more clamping force**

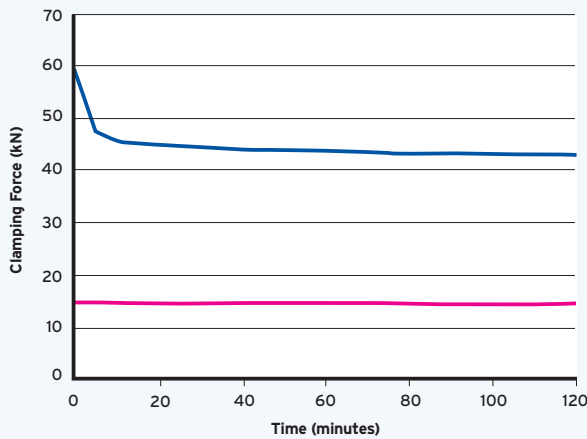

**M20: Up to 3.5 times more clamping force**

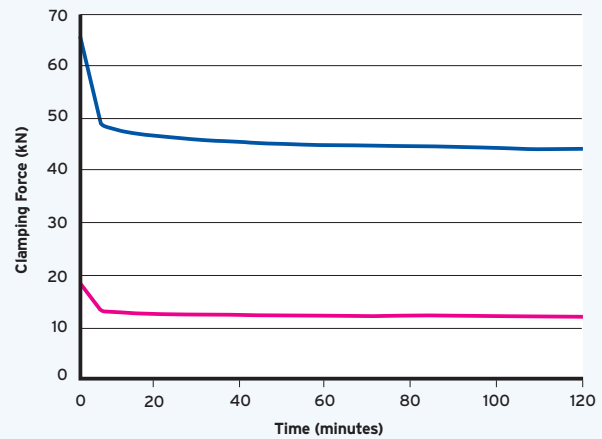

As with any structural bolt, immediately after installation the bolt relaxes until a typical clamping force is reached. The typical clamping force of the Hollo-Bolt (HCF) is over **three times higher** than the same sized product without the HCF mechanism. This results in a more secure connection and a greater force that has to be overcome before displacement begins.

## Displacement Typical Performance Increase

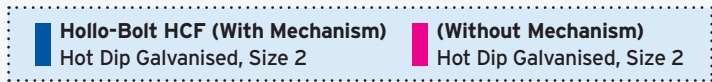

**M16: Connection Load vs Ply Displacement**

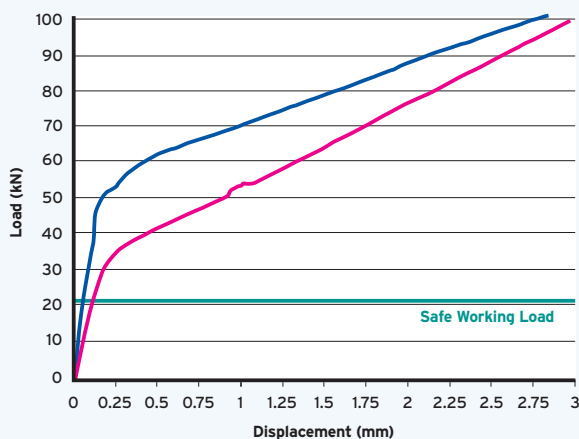

**M20: Connection Load vs Ply Displacement**

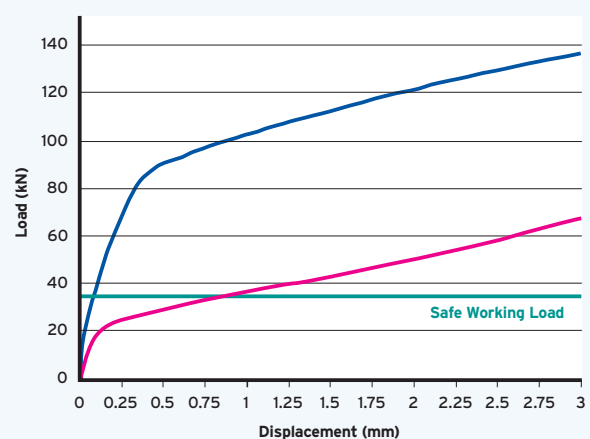

The graphs above show the significance of increased clamping force. The blue curve demonstrates the superior performance of the Hollo-Bolt HCF in contrast to M16 and M20 sized products without Lindapter's patented mechanism. At Safe Working Load, displacement (movement in the connection) is minimised when using the Hollo-Bolt HCF for a safer and more secure connection.

➤ Graphs for illustration purposes only, see page 42 and 43 for connection design.

# Hollo-Bolt Safe Working Loads

The Hollo-Bolt is featured in the BCSA and SCI design guide 'Joints in Steel Construction - Simple Connections', please refer to this guide for designing primary structural connections. For connections to secondary steelwork, please refer to the tables below.

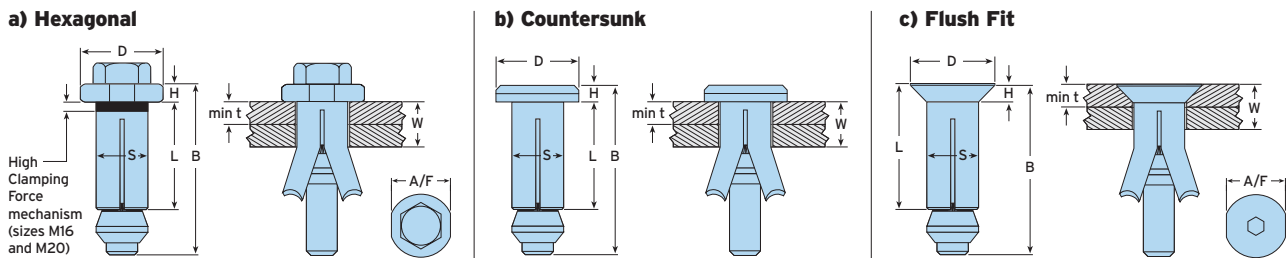

a) Hexagonal		b) Countersunk				Sleeve		Collar			Tightening Torque Nm	Safe Working Loads (5:1 Factor of Safety)	
Product Code	Bolt Length B mm	Product Code	Bolt Length B mm	Clamping Thickness W mm	Outer Ply min t mm	Length L mm	Outer Ø S mm	Height H mm	Ø D mm	A/F mm		Tensile kN	Single Shear kN
HB08-1	M8 x 50	HBCSK08-1	M8 x 50	3 - 22	-	30	13.75	5	22	19	23	4.0	5.0
HB08-2	M8 x 70	HBCSK08-2	M8 x 70	22 - 41	-	49	13.75	5	22	19	23	4.0	5.0
HB08-3	M8 x 90	HBCSK08-3	M8 x 90	41 - 60	-	68	13.75	5	22	19	23	4.0	5.0
HB10-1	M10 x 55	HBCSK10-1	M10 x 50	3 - 22	-	30	17.75	6	29	24	45	8.5	10.0
HB10-2	M10 x 70	HBCSK10-2	M10 x 70	22 - 41	-	48	17.75	6	29	24	45	8.5	10.0
HB10-3	M10 x 90	HBCSK10-3	M10 x 90	41 - 60	-	67	17.75	6	29	24	45	8.5	10.0
HB12-1	M12 x 60	HBCSK12-1	M12 x 55	3 - 25	-	35	19.75	7	32	30	80	10.5	15.0
HB12-2	M12 x 80	HBCSK12-2	M12 x 80	25 - 47	-	57	19.75	7	32	30	80	10.5	15.0
HB12-3	M12 x 100	HBCSK12-3	M12 x 100	47 - 69	-	79	19.75	7	32	30	80	10.5	15.0
HB16-1	M16 x 75	HBCSK16-1	M16 x 70	12 - 29	8	41.5	25.75	8	38	36	190	21.0	30.0
HB16-2	M16 x 100	HBCSK16-2	M16 x 100	29 - 50	8	63	25.75	8	38	36	190	21.0	30.0
HB16-3	M16 x 120	HBCSK16-3	M16 x 120	50 - 71	8	84	25.75	8	38	36	190	21.0	30.0
HB20-1	M20 x 90	-	-	12 - 34	8	50	32.75	10	51	46	300	35.0	40.0
HB20-2	M20 x 120	-	-	34 - 60	8	76	32.75	10	51	46	300	35.0	40.0
HB20-3	M20 x 150	-	-	60 - 86	8	102	32.75	10	51	46	300	35.0	40.0



Sizes M16 and M20, known as the Hollo-Bolt (HCF), feature a High Clamping Force mechanism to produce three times more clamping force than the same sized product without the mechanism. Turn to **pages 40 and 41** to see the significance of clamping force and the superior performance of this unique product.

c) Flush Fit				Sleeve		Collar			Tightening Torque Nm	Safe Working Loads (5:1 Factor of Safety)	
Product Code	Countersunk Bolt B mm	Clamping Thickness W mm	Outer Ply min t mm	Length L mm	Outer Ø S mm	Height H mm	Ø D mm	Installation Nut A/F mm		Tensile kN	Single Shear kN
HBFF08-1	M8 x 50	10 - 27	8	35	13.75	5	24	19	23	4.0	5.0
HBFF08-2	M8 x 70	27 - 45	8	54	13.75	5	24	19	23	4.0	5.0
HBFF08-3	M8 x 90	45 - 64	8	73	13.75	5	24	19	23	4.0	5.0
HBFF10-1	M10 x 50	12 - 27	10	36	17.75	6	30	24	45	8.5	10.0
HBFF10-2	M10 x 70	27 - 45	10	54	17.75	6	30	24	45	8.5	10.0
HBFF10-3	M10 x 90	45 - 64	10	73	17.75	6	30	24	45	8.5	10.0
HBFF12-1	M12 x 55	12 - 30	10	42	19.75	7	33	30	80	10.5	15.0
HBFF12-2	M12 x 80	30 - 52	10	64	19.75	7	33	30	80	10.5	15.0
HBFF12-3	M12 x 100	52 - 74	10	86	19.75	7	33	30	80	10.5	15.0

Hollo-Bolts can be used on a wide variety of steel hollow shape sections. Safe working loads shown are based on use in S275 structural hollow section and are applicable to the Hollo-Bolt only in both tension and shear. Failure of the section, particularly on those with thin walls and a wide chord face, could occur at a lower figure and its strength should be checked by a qualified Structural Engineer.

Published by the SCI/BCSA Connections Group, 'Joints in Steel Construction - Simple Connections' provides design guidance for using Hollo-Bolt and structural steelwork connections in buildings designed using the 'Simple Method' i.e. braced frames where connections carry mainly shear and axial loads only. For more information please contact The Steel Construction Institute on +44 (0) 1344 636525 or visit [www.steel-sci.com](http://www.steel-sci.com)



# Hollo-Bolt Characteristic Resistances

The values listed in the tables below are to be used when designing bolted connections to Eurocode 3 only, they are **not** standard safe working loads. The Declaration of Performance (DoP No.001) can be viewed on the website: [www.Lindapter.com/About/CE](http://www.Lindapter.com/About/CE)



## Hollo-Bolt Hexagonal

Product Code	Nominal Size	Tensile	Shear	Sleeve
		F <sub>t,Rk</sub>	F <sub>v,Rk</sub>	Material Strength
		kN	kN	N/mm <sup>2</sup>
<b>HB08</b>	M8	23.1	32.9	430
<b>HB10</b>	M10	39.6	54.2	430
<b>HB12</b>	M12	45.8	71.0	430
<b>HB16</b>	M16	84.3	139.0	430
<b>HB20</b>	M20	124.0	211.0	390

## Hollo-Bolt Hexagonal Stainless Steel

Product Code	Nominal Size	Tensile	Shear	Sleeve
		F <sub>t,Rk</sub>	F <sub>v,Rk</sub>	Material Strength
		kN	kN	N/mm <sup>2</sup>
<b>HBST08</b>	M8	26.8	30.7	500
<b>HBST10</b>	M10	46.0	51.0	500
<b>HBST12</b>	M12	53.3	65.0	500
<b>HBST16</b>	M16	98.0	128.0	500
<b>HBST20</b>	M20	154.0	205.0	500

## Hollo-Bolt Countersunk

Product Code	Nominal Size	Tensile	Shear	Sleeve
		F <sub>t,Rk</sub>	F <sub>v,Rk</sub>	Material Strength
		kN	kN	N/mm <sup>2</sup>
<b>HBCSK08</b>	M8	23.1	32.9	430
<b>HBCSK10</b>	M10	39.6	54.2	430
<b>HBCSK12</b>	M12	45.8	71.0	430
<b>HBCSK16</b>	M16	84.3	139.0	430

## Hollo-Bolt Countersunk Stainless Steel

Product Code	Nominal Size	Tensile	Shear	Sleeve
		F <sub>t,Rk</sub>	F <sub>v,Rk</sub>	Material Strength
		kN	kN	N/mm <sup>2</sup>
<b>HBSTCSK08</b>	M8	26.8	30.7	500
<b>HBSTCSK10</b>	M10	46.0	51.0	500
<b>HBSTCSK12</b>	M12	53.3	65.0	500
<b>HBSTCSK16</b>	M16	98.0	128.0	500



Sizes M16 and M20, known as the Hollo-Bolt (HCF), feature a High Clamping Force mechanism to produce three times more clamping force than the same sized product without the mechanism. Turn to **pages 40 and 41** to see the significance of clamping force and the superior performance of this unique product.

## Hollo-Bolt Flush Fit

Product Code	Nominal Size	Tensile	Shear	Sleeve
		F <sub>t,Rk</sub>	F <sub>v,Rk</sub>	Material Strength
		kN	kN	N/mm <sup>2</sup>
<b>HBFF08</b>	M8	23.1	32.9	430
<b>HBFF10</b>	M10	39.6	54.2	430
<b>HBFF12</b>	M12	45.8	71.0	430

## Hollo-Bolt Flush Fit Stainless Steel

Product Code	Nominal Size	Tensile	Shear	Sleeve
		F <sub>t,Rk</sub>	F <sub>v,Rk</sub>	Material Strength
		kN	kN	N/mm <sup>2</sup>
<b>HBSTFF08</b>	M8	26.8	30.7	500
<b>HBSTFF10</b>	M10	46.0	51.0	500
<b>HBSTFF12</b>	M12	53.3	65.0	500

Hollo-Bolt lengths 1, 2 and 3 are covered by ETA 10/0416. The characteristic values are used to determine the design resistance of the Hollo-Bolt. The design resistance is calculated by dividing the characteristic value by a partial factor  $\gamma_{m2}$ . The partial factor is a nationally determined parameter (eg:  $\gamma_{m2} = 1.25$  in UK).

For Hollo-Bolt safe working loads with a Factor of Safety of 5:1 please refer to the tables on **page 42** of this catalogue. The characteristic values are valid for the assembly itself, in any connection detail the design resistance of the connection may be limited to a lesser value. For example, when the thickness of the connected component is small, pull out failure may occur before failure of the Hollo-Bolt. Design checks should be carried out to determine the static design resistance.

The SCI Greenbook publication 'Joints in Steel Construction: Simple Joints to Eurocode 3' contains a number of checks on the section. The characteristic values are only valid when the Hollo-Bolts are installed as per Lindapter's installation instructions. For more information please contact The Steel Construction Institute on +44 (0) 1344 636525 or visit [www.steel-sci.com](http://www.steel-sci.com)



# Holo-Bolt Preparation and Installation

Please ensure that the holes are drilled into both the fixture and the section according to the drilling guidance below. Please note that the holes are slightly larger than standard bolt clearance holes to accommodate the sleeve and cone.

## Hexagonal and Countersunk

Type		Outer Ply min t mm	Clearance Hole Ø d1 mm	Hole Distances		Edge Distances B + C mm
Hex	Countersunk			min A mm	min B mm	
HB08	HBCSK08	-	14 (+1.0/-0.2)	35	13	> 17.5
HB10	HBCSK10	-	18 (+1.0/-0.2)	40	15	> 22.5
HB12	HBCSK12	-	20 (+1.0/-0.2)	50	18	> 25.0
HB16	HBCSK16	8	26 (+2.0/-0.2)	55	20	> 32.5
HB20	-	8	33 (+2.0/-0.2)	70	25	> 33.0

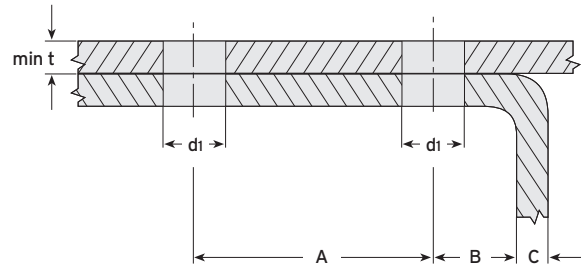

► Sizes M16 and M20 require outer ply thickness (min t) to be at least 8mm.



### How to install...

- 1) Align pre-drilled fixture and section then insert the Holo-Bolt<sup>a)</sup>.
- 2) Grip Holo-Bolt collar with an open ended spanner.
- 3) Using a calibrated torque wrench, tighten the central bolt to the recommended torque<sup>b)</sup>.

▶ Watch the Holo-Bolt installation video at [www.Lindapter.com](http://www.Lindapter.com)

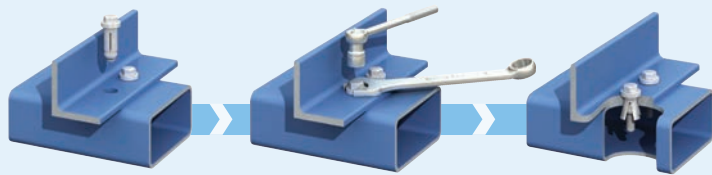

## Flush Fit

Type	Outer Ply min t mm	Clearance Hole Ø d1 mm	Countersunk		Hole Distances		Edge Distances B + C mm
			d2 mm	t1 mm	min A mm	min B mm	
HBFF08	8	14 (+1.0/-0.2)	27	6.5	35	13	> 17.5
HBFF10	10	18 (+1.0/-0.2)	31	6.5	40	15	> 22.5
HBFF12	10	20 (+1.0/-0.2)	35	7.5	50	18	> 25.0

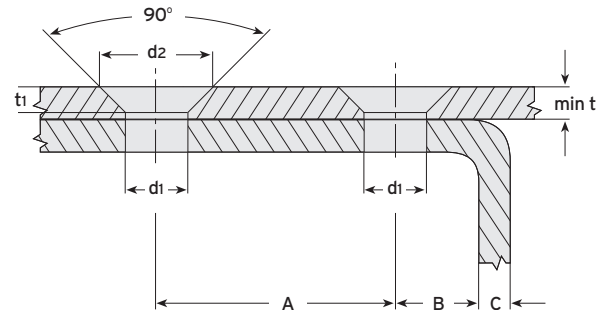

### How to install...

- 1) Align pre-drilled fixture and section then insert the Holo-Bolt<sup>a)</sup>.
- 2) Apply the installation nut and grip with an open ended spanner.
- 3) Using a calibrated torque wrench, tighten the central countersunk bolt to the recommended torque<sup>b)</sup>.

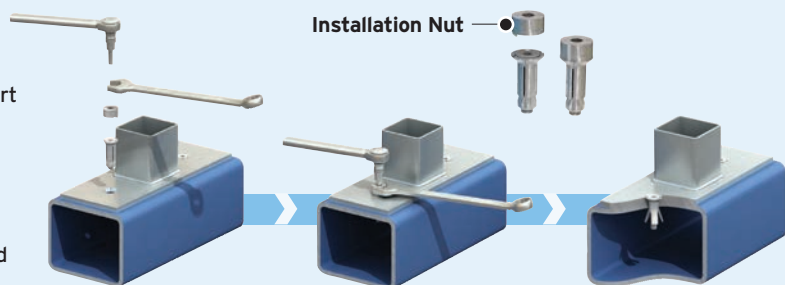

### Notes:

- a) Before tightening, ensure that the materials that are to be connected together are touching. See page 42 for tightening torque.
- b) Power tools, such as an impact wrench, may be used to speed up the tightening of the Holo-Bolt. However, when using power tools, always complete the tightening process with a calibrated torque wrench to ensure the correct torque is applied to the Holo-Bolt.

GIRDER CLAMPS  
RAIL FIXINGS  
LIFTING POINTS  
HOLLO-BOLT  
FLOOR FIXINGS  
SUPPORT FIXINGS  
DECKING FIXINGS